

UIM V2

2012-8-30

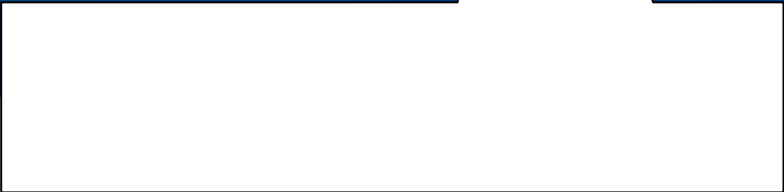

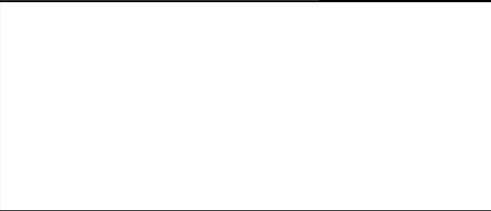

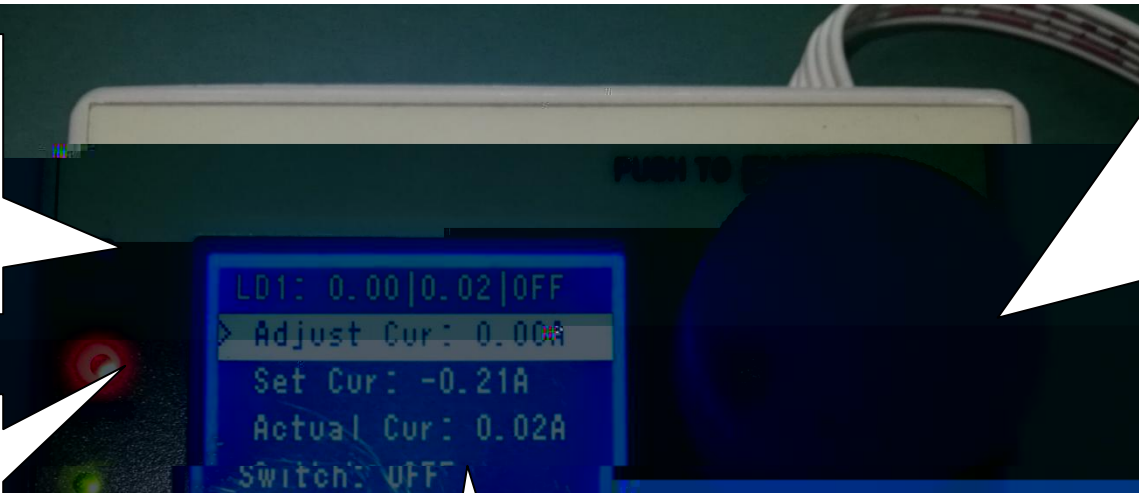
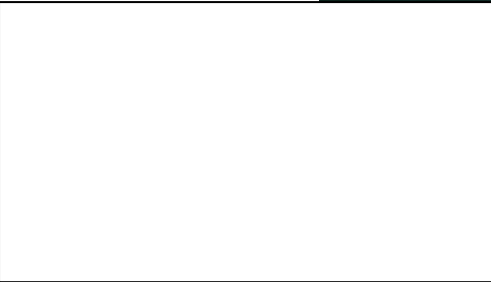
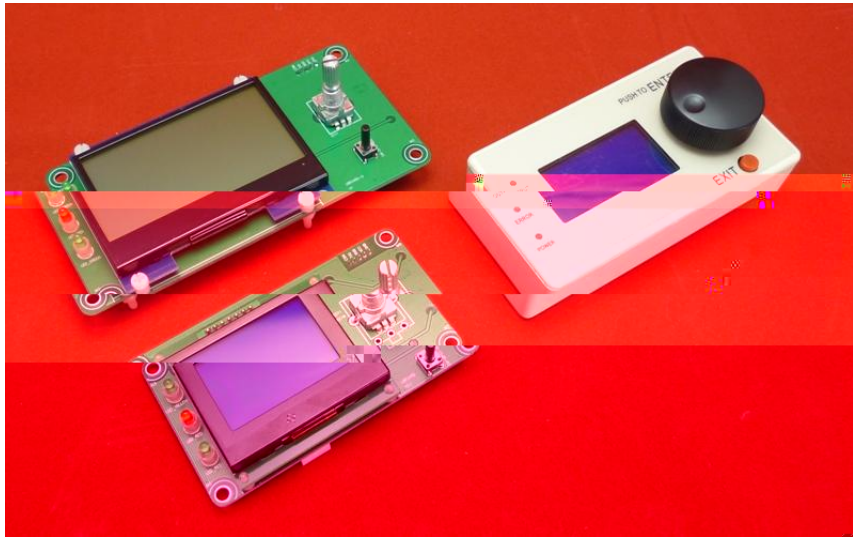
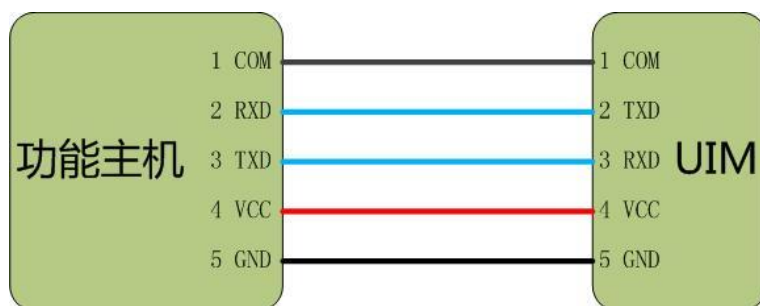
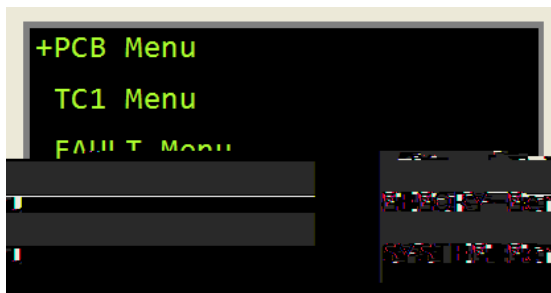



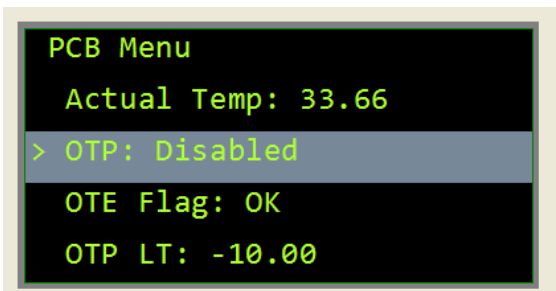
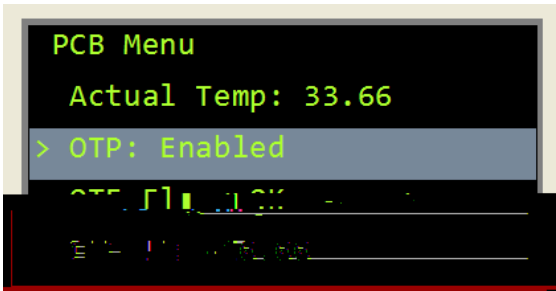
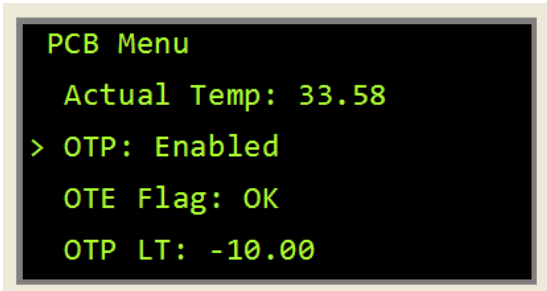
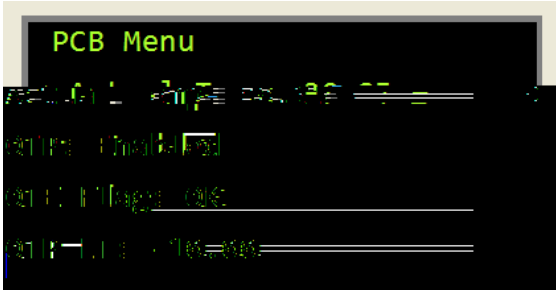

```
FAULT Menu
= Cmd: Exit
  TC1 Rt Open Circuit
  TC1 Over Temp!
```

```
>SV: 25.00
  PV: -67.14
```

```
PCB Menu
Actual Temp: 13.08
! Pressing: 6.4s 5
OTE Flag: OK
Hys Temp: 10.00
```

```
PCB Menu
Actual Temp: 34.16
! Save Disabled
OTE Flag: OK
OTP LT: -10.00
```

		v
